

Catalogue 2011

ABBRACCI
DADA

www.dasradiatori.pl



radiatori d'arredo

ABBRACCI

design Marco Poletti



radiatori d'arredo

ABBRACCI, la nuova forma del calore.

Il nuovo radiatore di D.A.S., disegnato dall'arch. Marco Poletti, trova ideale collocazione sia nell'ambiente bagno che nella zona giorno come esclusivo elemento d'arredo.

Abbracci è un radiatore di nuova generazione poiché oltre a consentire innumerevoli configurazioni, grazie all'estrema snodabilità e al numero variabile dei moduli di cui si compone, può essere modificato nella forma direttamente dall'utente anche dopo l'installazione. È inoltre di semplice montaggio e libero da ogni vincolo di posizionamento degli attacchi dell'acqua (parete/parete; parete/pavimento; pavimento/pavimento; soffitto/parete).

Si può scegliere fra quattro, cinque o sei Abbracci, ciascuno formato da 4 moduli. Il radiatore infatti si compone di 16, 20 e 24 moduli (diametro 3 cm e raggio di curvatura 30 cm) ad innesto con blocco di rotazione a tenuta di pressione, tutto realizzato in acciaio inox.

Abbracci è un radiatore attento all'ambiente, riciclabile al 99% che impiega un basso quantitativo d'acqua garantendo risparmio energetico ed elevata radiazione calorica. E' disponibile nelle finiture lucida e spazzolata e nelle versioni ad acqua o elettrica (con opzione di controllo in remoto).















DADA

design Marco Poletti



radiatori d'arredo

DADA

Frutto della sinergia tra il know-how consolidato dell'azienda D.A.S. Radiatori d'arredo e la creatività dell'arch. Marco Poletti, DADA è una Collezione dal design inedito e d'ispirazione non solo geometrica, ma anche emozionale.

La Collezione attraverso un particolare sistema modulare a tre altezze (60 cm; 120 cm; 180 cm) e la combinazione di varianti decorative, materiche e funzionali, interpreta il radiatore non più come un corpo scaldante, ma come un elemento d'arredo personalizzabile.

Metallo e resina, luci e colori sono alcune delle proposte che attraverso le tre soluzioni, "Piena", "Vuota" e "Riempita", consentono anche di esprimerne la forte valenza emozionale.

















FINITURE



Acciaio Spazzolato



Nero Grafite



Acciaio Super Mirror
Acciaio Satinato



Bianco Spatolato
Acciaio Satinato

FUNZIONI



Luce



Specchio



Portasciugamano



Portaccappatoio





SCHEDE TECNICHE

4 ABBRACCI

CODICE	L (mm)	N° MODULI	INT. MIN.	INT. MAX.	PROF. MINIMA	Watt Δt 50°C	Kcal Δt 50°
4-ABBR SAT	4000	16	200	1500	220	640	550
4-ABBR LUC	4000	16	200	1500	220	640	550

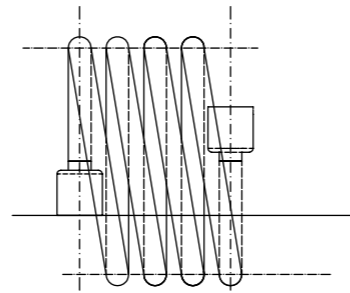

5 ABBRACCI

CODICE	L (mm)	N° MODULI	INT. MIN.	INT. MAX.	PROF. MINIMA	Watt Δt 50°C	Kcal Δt 50°
5-ABBR SAT	5000	20	200	1500	220	790	680
5-ABBR LUC	5000	20	200	1500	220	790	680

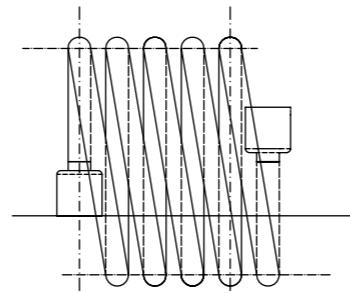

6 ABBRACCI

CODICE	L (mm)	N° MODULI	INT. MIN.	INT. MAX.	PROF. MINIMA	Watt Δt 50°C	Kcal Δt 50°
6-ABBR SAT	6000	24	200	1500	220	955	820
6-ABBR LUC	6000	24	200	1500	220	955	820

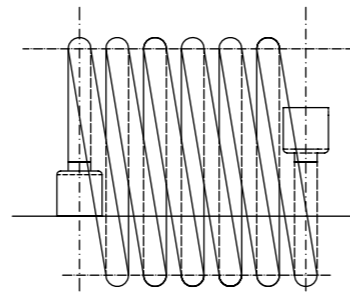

RAGGIO ABBRACCI

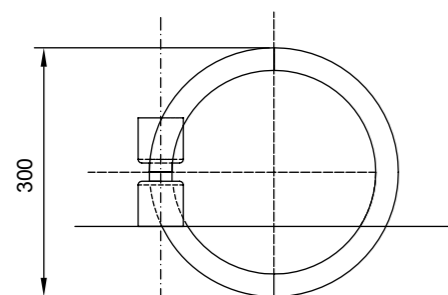

INGOMBRO MINIMO

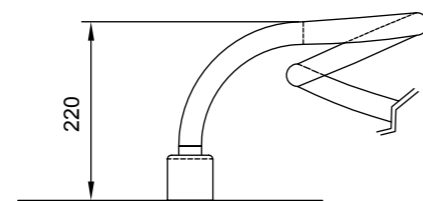

DISTANZA FISSAGGIO USCITA TUBI

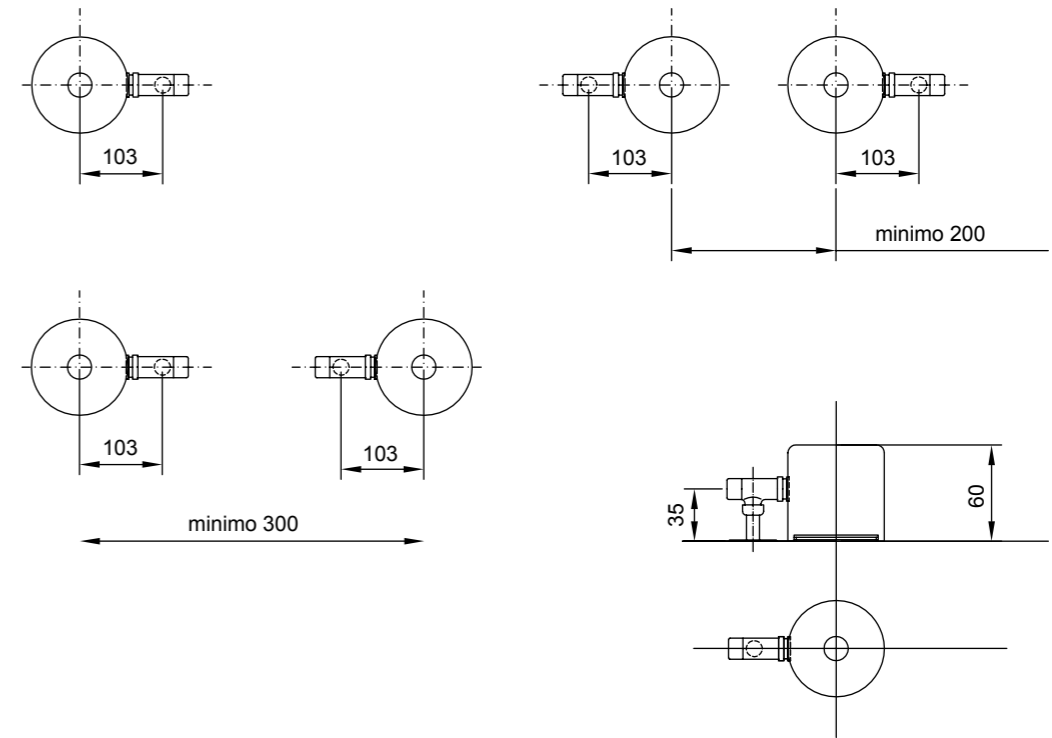

FISSAGGI E CONNESSIONI

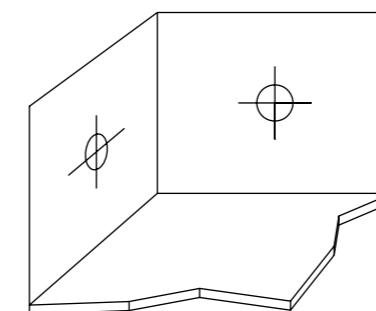

PARETE-PARETE

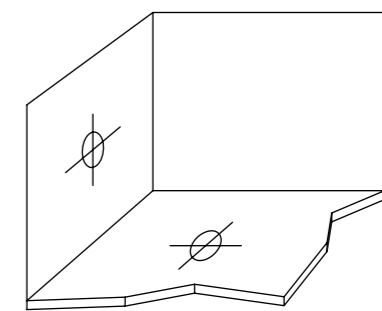

PARETE-PAVIMENTO

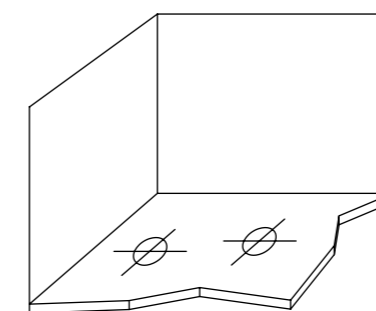

PAVIMENTO-PAVIMENTO

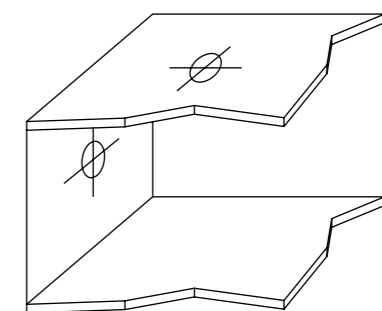

SOFFITTO-PARETE

COMPOSIZIONI TIPO DA CATALOGO

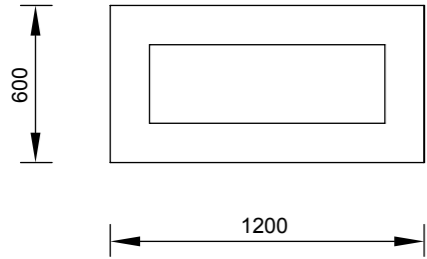

CODICE	DESCRIZIONE
DDR120-60	VUOTO Inox Super Mirror L1200xH600
DPAN90-30	RIEMPIMENTO Resina Bianca

Composizione pag. 26 - L 1200 x H 600

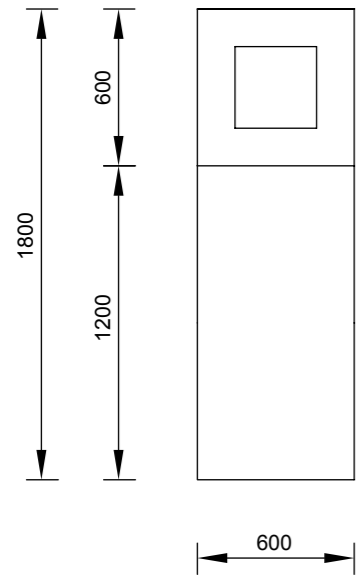

CODICE	DESCRIZIONE
DDV60-60	CORNICE Resina Bianca H600xL600
LED-DDV60	LED per Retroilluminazione
DDP120-60	PANNELLO Inox Super Mirror L1200xH600

Composizione pag. 27 - H 1800 x L 600

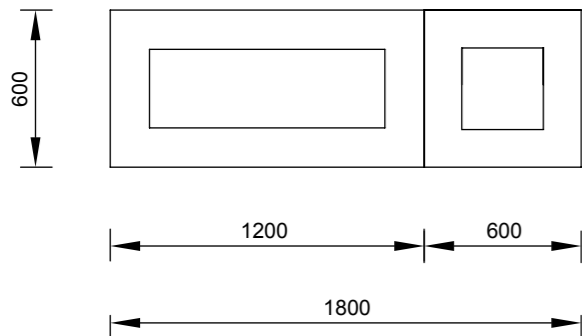

CODICE	DESCRIZIONE
DDR120-60	VUOTO Inox Satinato L1200xH600
DPAN90-30	RIEMPIMENTO Ral 5022
DDV60-60	CORNICE Ral 5022 H600xL600
056 003	PORTASALVIETTE Inox Super Mirror

Composizione pag. 30-31 - L 1800 x H 600

COMPOSIZIONI TIPO DA CATALOGO

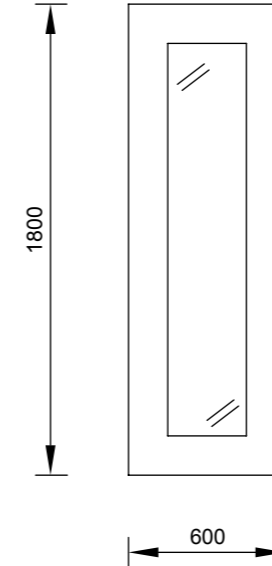

CODICE	DESCRIZIONE
DDR180-60	VUOTO Col. Spec. Grafite H1800xL600
DPAN150-30	RIEMPIMENTO Inox Super Mirror

Composizione pag. 35 - H 1800 x L 600

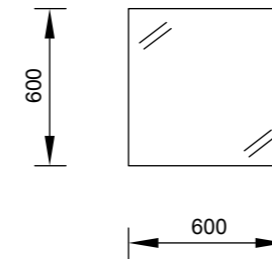

CODICE	DESCRIZIONE
DDP60-60	PANNELLO Inox Super Mirror H600xL600

Composizione pag. 36 - H 600 x L 600

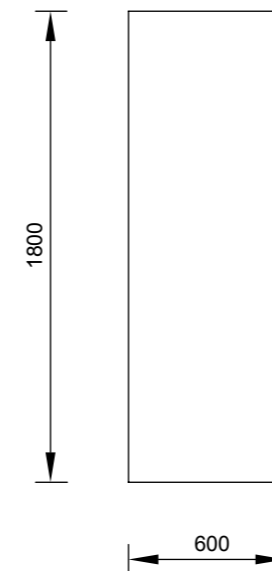

CODICE	DESCRIZIONE
DDP180-60	PANNELLO Col. Spec. Bronzo H1800xL600

Composizione pag. 42 - H 1800 x L 600

CONNESSIONI BASE - DADA VERTICALE

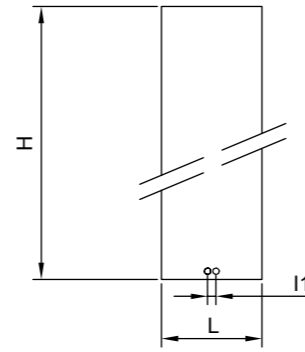

VALVOLA REVERSE

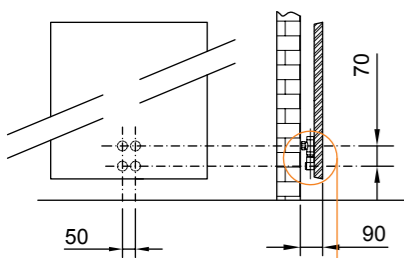

VALVOLA BITUBO

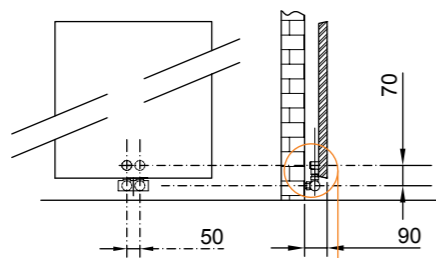

VALVOLA SATELLITE

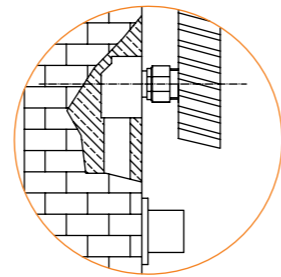
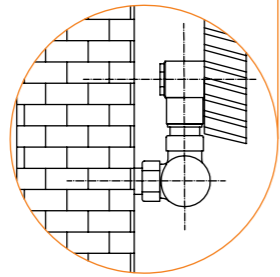
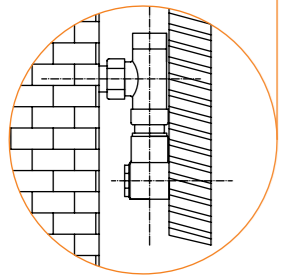
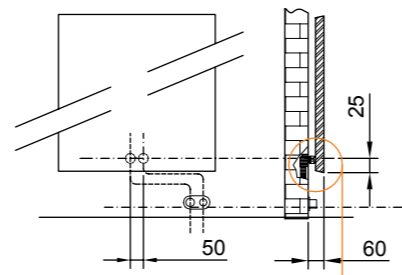

CONNESSIONI A RICHIESTA - DADA VERTICALE

DIMENSIONI REALIZZABILI

H	L	I	Z
1800	600	550	1750
1200	600	550	1150
600	600	550	550
1800*	400	350	1750
1200*	400	350	1150
1800*	750	700	1750
1200*	750	700	1150

* Piastre realizzabili solo a PANNELLO

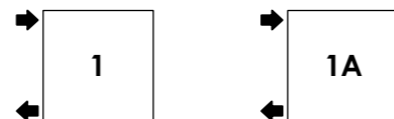
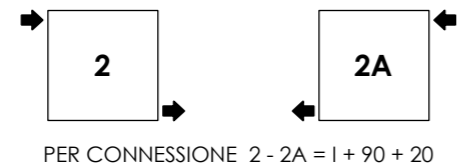
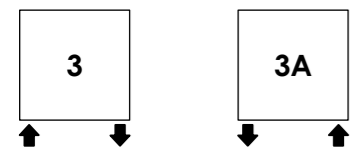
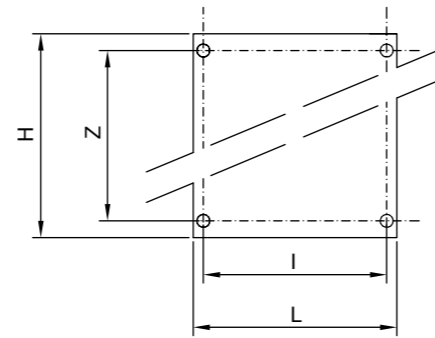

CONNESSIONI BASE - DADA ORIZZONTALE

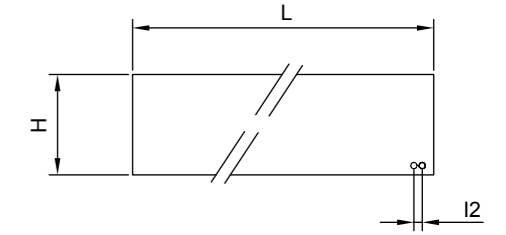

VALVOLA REVERSE

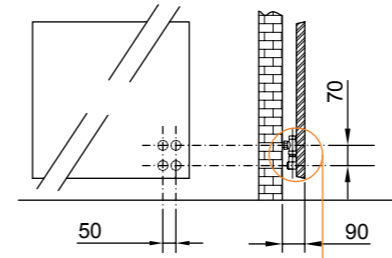

VALVOLA BITUBO

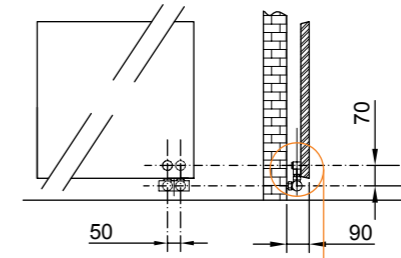

VALVOLA SATELLITE

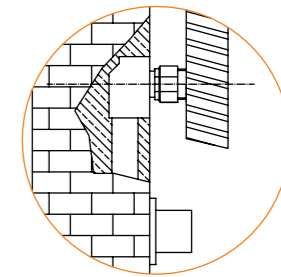
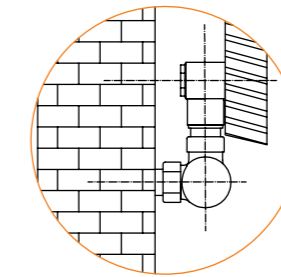
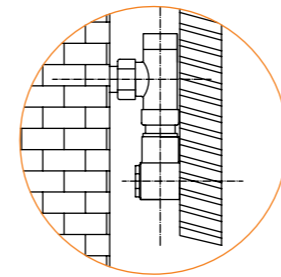
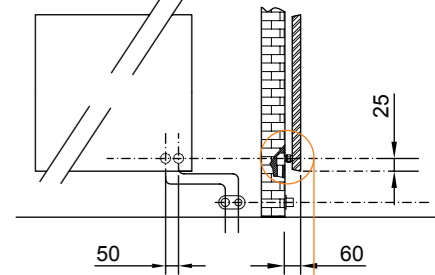

CONNESSIONI A RICHIESTA - DADA ORIZZONTALE

DIMENSIONI REALIZZABILI

H	L	ZO	IO
600	1800	550	1750
600	1200	550	1150
600	600	550	550
400	1800*	350	1750
400	1200*	350	1150
750	1800*	700	1750
750	1200*	700	1150

* Piastre realizzabili solo a PANNELLO

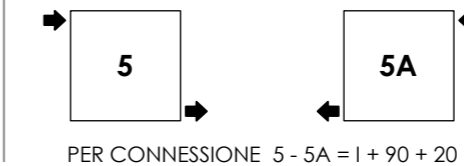
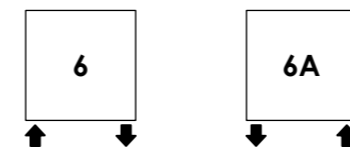
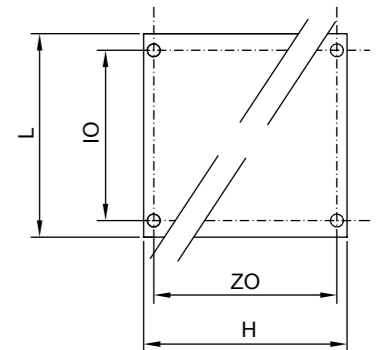

BIG DADA

Due versioni: PANNELLO e VUOTO CON RIEMPIMENTO
 Two versions : PANEL and EMPTY SPACE WITH FILLING
 Deux versions : PANNEAU et VIDE REMPLI

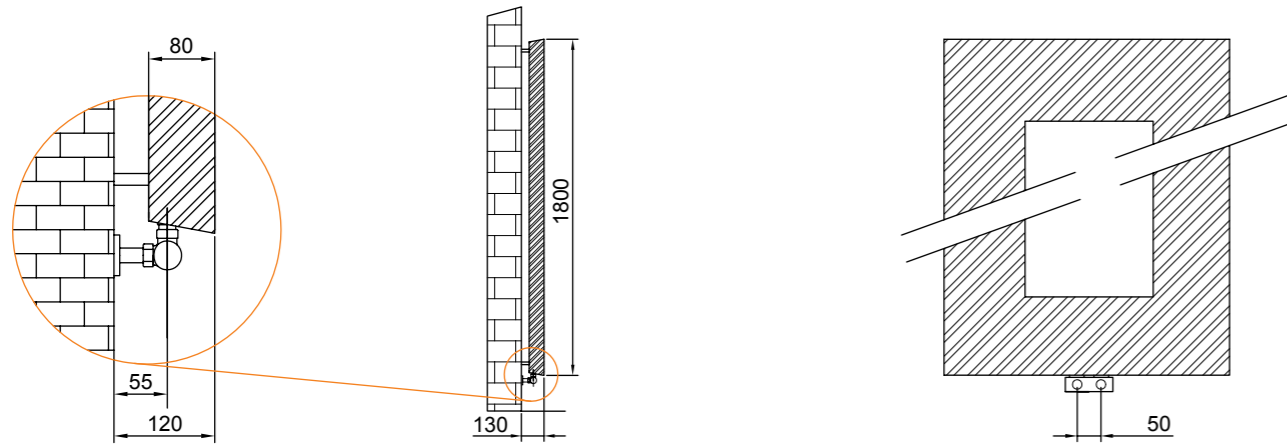

CODICE	BIG DADA H1800xL600	I (mm)	H (mm)	L (mm)	Watt Δt 50°C	Kcal Δt 50°
BIGDD180-60	PANNELLO	50	1800	600	2758	2380
BIGDDR180-60	VUOTO	50	1800	600	2758	2380
DPAN150-30	RIEMPIMENTO		1500	300		

DADA CORNER

Due versioni: VUOTO CON MENSOLE e VUOTO CON RIEMPIMENTO
 Two versions: EMPTY SPACE WITH SHELVES and EMPTY SPACE WITH FILLING
 Deux versions: VIDE AVEC CONSOLES et VIDE AVEC REMPLISSAGE

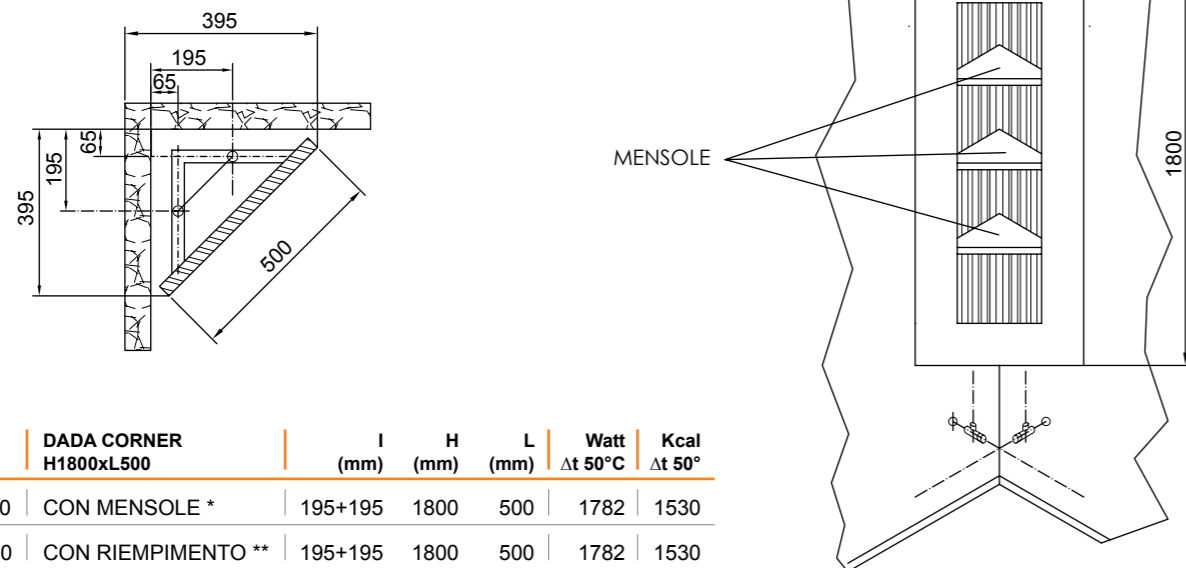

CODICE	DADA CORNER H1800xL500	I (mm)	H (mm)	L (mm)	Watt Δt 50°C	Kcal Δt 50°
CDDV180-50	CON MENSOLE *	195+195	1800	500	1782	1530
CDDR180-50	CON RIEMPIMENTO **	195+195	1800	500	1782	1530

* mensole abbinare al colore della cornice
 ** riempimento Inox Super Mirror

ACCIAIO INOX STAL NIERDZEWNA-INOX

Złoty Pr kowany

Matt Orientalny

Biały matowy "stary tynk"

Czer połysk "natura"

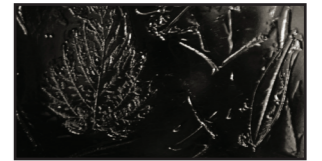
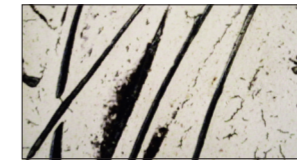

Oro Rigato

Oriente Opaco

Bianco Spatolato Opaco

Nero Lucido Natura

La speciale finitura rende ogni pezzo unico ed irripetibile, in quanto eseguita manualmente da personale esperto.

The special finish makes each piece unique and unrepeatable, as performed manually by trained personnel.

La finition spéciale rend chaque pièce unique et irremplaçable, comme effectuée manuellement par du personnel qualifié.

ACCIAIO INOX STAL NIERDZEWNA-INOX

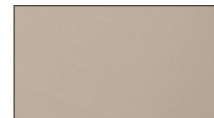

Super Mirror



Gold Mirror

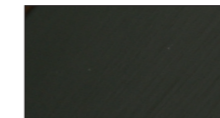

Black Mirror

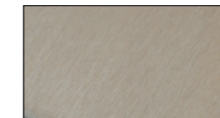

Inox Satinato

TABELLA COLORI



RAL 9010

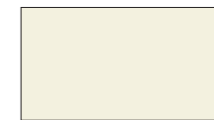

RAL 9001



RAL 1013

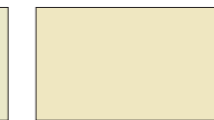

RAL 1015

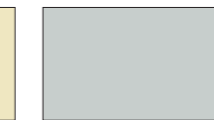

RAL 7035

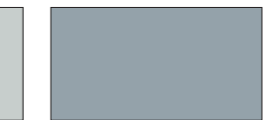

RAL 7001

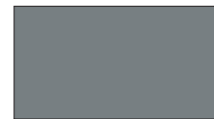

RAL 7037



RAL 9005



RAL 5024

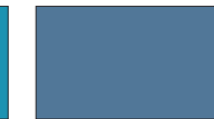

RAL 5014



RAL 5015



RAL 5010



RAL 5022

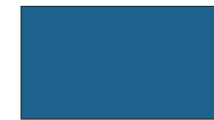

RAL 5023

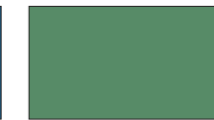

RAL 6011



RAL 6017



RAL 6019



RAL 1021



RAL 2008



RAL 3000



RAL 3003



RAL 3005



RAL 4010

COLORI SPECIALI FARBY METALICZNE

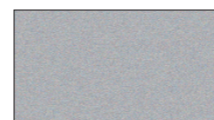

Cod. SP02

Alluminio Satinato
Aluminium Satin



Cod. SP01

Acciaio
Steel Color



RAL 1036

Oro Satinato
Gold Satin

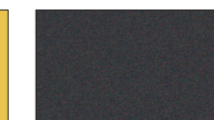

Cod. SP04

Nero Grafite
Graphite Black



9006 mat



RAL 9023

Grigio Titanio
Metallizzato
Titanium Grey Metallic

I colori, per limiti tecnici di stampa, sono da considerarsi indicativi e non impegnativi.

For technical reasons associated with colour reproduction in the print process the following shades are for guidance purposes only.

CONDIZIONI GENERALI DI VENDITA

Con il conferimento dell'ordine si intendono integralmente accettate tutte le seguenti condizioni di vendita:

ORDINI

Gli ordini impartiti impegnano definitivamente il Cliente che deve dichiarare di conoscere e accettare tutte le condizioni di vendita.

Si accettano unicamente ordini trasmessi per iscritto, via fax o e-mail. Gli ordini particolari, quali fuori misura e colorati, se già in lavorazione, non possono essere né modificati né annullati trascorse le 24 ore dalla conferma dell'ordine.

Ordini telefonici devono essere seguiti da conferma scritta. Qualora l'ordine o una sua modifica e/o specifica fosse solo verbale, la D.A.S. viene automaticamente sollevata da ogni responsabilità di errori di evasione dello stesso.

PREZZI

I prezzi del nostro listino possono essere soggetti a variazioni e non sono impegnativi.

Essi si intendono franco nostra sede di Carate Brianza, salvo diversi accordi, I.V.A. esclusa.

PAGAMENTI

I termini di pagamento specificati in fattura si intendono tassativi: ogni variazione che non sia stata preventivamente pattuita con la nostra sede, verrà respinta. Il ritardato pagamento delle forniture darà luogo all'addebito degli interessi e sarà nostra facoltà sospendere la consegna ed eventuali ordini già accettati.

Anche in caso di contestazione i pagamenti non possono essere sospesi.

TERMINI DI CONSEGNA

I termini di consegna non costituiscono impegni e non possono dar luogo a penalità o all'annullamento degli ordini. Se il termine di consegna non potesse essere rispettato per qualsiasi motivo, il Cliente non avrà diritto a esigere nessun indennizzo, annullamento o modifica all'ordine conferitoci, né respingerne la spedizione.

DATI IDENTIFICATIVI DEL CLIENTE

Il Cliente è responsabile di tutti i dati di identificazione forniti alla D.A.S. quali: Denominazione e Ragione Sociale, Sede Legale, eventuale indirizzo per consegna materiale, Codice Fiscale, Partita IVA e quant'altro specificatamente richiesto in materia dalla legislazione vigente e solleva la D.A.S. da ogni responsabilità per quanto concerne l'inesattezza dei dati forniti.

TRASPORTO

La merce viaggia a rischio e pericolo del committente anche se venduta franco destino.

E' obbligo del committente verificare l'integrità dell'imballo alla consegna ed eventuali reclami dovranno essere segnalati sul d.d.t. controfirmato dal trasportatore.

IMBALLO

L'imballaggio standard è compreso nel prezzo di vendita, salvo eventuali imballi speciali che saranno addebitati a parte.

RESPONSABILITÀ

Tutti i nostri articoli sono accuratamente provati e controllati. La nostra responsabilità sulla qualità dei materiali si limita, previa nostra autorizzazione, ad accettare il reso, in porto franco, di pezzi riscontrati difettosi per disporre la sostituzione, senza essere tenuti a corrispondere alcun indennizzo. Non accettiamo alcuna responsabilità ove i materiali da noi forniti risultassero manomessi.

Si esclude qualsiasi tipo di risarcimento per danni diretti o indiretti causati dalla posa in opera di materiale difettoso. E' fatto assoluto divieto agli acquirenti di effettuare qualsiasi lavorazione ulteriore sugli articoli di nostra produzione.

GARANZIA E CONDIZIONI D'USO

I nostri radiatori sono garantiti, esenti da difetti di fabbricazione, per il periodo di anni 2, così come le finiture degli stessi purché vengano rispettate le condizioni seguenti:

- immagazzinamento idoneo;
- installazione effettuata secondo le norme da personale qualificato;
- alimentazione con acqua non corrosiva;
- pressione massima d'esercizio 6 bar, tranne dove diversamente indicato;
- gli impianti dovranno essere sigillati: non è ammesso il vaso d'espansione aperto;
- sui punti di tenuta dei radiatori non è ammesso l'utilizzo di canapa o simili;
- per i radiatori elettrici dovranno essere utilizzate resistenze e liquido di esclusiva fornitura e preparati dalla D.A.S. per l'istallazione;
- la garanzia decade se dopo il primo riempimento siano lasciati senz'acqua;
- per la pulizia esterna non possono essere usati prodotti abrasivi o chimicamente aggressivi di qualsiasi natura, essendo sufficiente un panno inumidito con acqua;
- i radiatori non possono in alcun modo essere sottoposti a sollecitazioni e condizioni d'uso che esulino dalla loro natura di corpi scaldanti. I nostri radiatori sono progettati e realizzati per presentare il minimo rischio di danno a persone per urto. Vanno comunque rispettate le elementari condizioni di sicurezza per evitare danni alle persone e/o cose per urto o altro. Nel caso di disabili e bambini, debbono essere seguite precauzioni particolari, inoltre gli imballi non devono essere lasciati alla portata di questi ultimi;
- durante l'installazione dovrà essere usata la massima cura per evitare danni al radiatore stesso.

TOLLERANZE

La conformità al campione, sia alla prima sia alle successive forniture, non deve intendersi in modo tassativo, giacché possono sussistere margini di tolleranza sia per quanto riguarda i colori, che i materiali e le misure.

MODIFICHE

E' facoltà della D.A.S. modificare o variare in qualunque momento e senza preavviso le caratteristiche tecniche, quali pesi, misure, superfici, forme, dimensioni e altro, illustrate nel listino, poiché trattasi di dati indicativi e non impegnativi.

RECLAMI

I reclami devono essere eseguiti entro 8 giorni dal ricevimento della merce.

Dopo tale termine non potranno essere da noi accettati.

RESI MERCE

L'unico motivo ammesso per i resi è l'accertata difettosità di fabbricazione nei termini descritti nelle condizioni di vendita. Il Cliente è tenuto ad informare la D.A.S. preventivamente dei difetti rilevati e nel caso in cui D.A.S. rilasci l'autorizzazione al reso, il Cliente potrà procedere al reso stesso. Non sono ammessi altri motivi al reso se non la difettosità di fabbricazione.

I resi senza autorizzazione verranno respinti al mittente.

La D.A.S. si riserva comunque la verifica del difetto esposto e l'addebito della sostituzione qualora i danni al radiatore non dipendano da difetti di fabbricazione.

FORO COMPETENTE

Per qualsiasi controversia è espressamente convenuto che si dovrà adire esclusivamente alle competenti autorità giudiziarie di Monza e per quanto non espressamente convenuto le norme di legge vigenti.

GENERAL CONDITIONS OF SALE

With order conferment all of the following sales conditions are considered to have been entirely accepted:

ORDERS

The orders made commit the Customer definitively, who must declare to be aware of and accept all the conditions of sale.

Only orders sent in writing, by fax or by e-mail are accepted. Particular orders, like special sizes and colours, cannot be modified or cancelled after 24 hours from the order if they are already being processed.

Orders by phone must be followed by written confirmation. If the order or modification and/or specification is only verbal, D.A.S. is automatically relieved of any responsibility for errors in processing it.

PRICES

The prices in our price list may be subject to changes and are not binding.

The prices are ex-works our registered offices of Carate Brianza, unless otherwise agreed on and are ex-VAT

PAYMENTS

The terms of payment specified in the invoice are binding: any change which has not been agreed on beforehand with our offices, will be rejected. Delayed payment of our supplies will lead to charging default interest and we will have the right to suspend delivery and any already accepted orders.

Even in the event of disputes, payments may not be suspended.

DELIVERY TERMS

The terms of delivery do not establish commitments and cannot lead to penalties or cancellation of the orders. If the delivery terms cannot be respected for any reason, the Customer will not have the right to claim any compensation, cancellation or modification to the order conferred, nor may it reject the shipment.

CUSTOMER IDENTIFICATION DATA

The Customer is responsible for all the identification data supplied to D.A.S. like: Name and Corporate Name, Registered Offices, any address for material delivery, Fiscal Code, VAT reg. no. and anything else specifically requested as regards the legislation in force, and relieves D.A.S. from any responsibility regarding the inaccuracy of the data provided.

TRANSPORT

The goods travel at the customer's risk and damage, even if they are sold free at destination.

The Customer is obliged to check the integrity of the packaging on delivery and any complaints must be indicated on the transport document signed by the transporter.

PACKAGING

The standard packaging is included in the sale price, without prejudice to any special packaging which will be charged separately.

RESPONSIBILITY

All our items are carefully tested and controlled. Our responsibility on the quality of the materials is limited, subject to our authorisation, to accepting returns, carriage paid, of parts found to be defective to provide replacements, without being liable to paying any compensation. We do not accept any responsibility where the material supplied by us should be found to have been tampered with.

Any kind of compensation for direct or indirect damage caused by laying defective material is excluded. It is absolutely forbidden for purchasers to carry out any further processing on the items manufactured by us.

GUARANTEE AND CONDITIONS OF USE

Our radiators are guaranteed to be free from any manufacturing defects for a period of 2 years, as are their finishings, as long as the following conditions are respected:

- suitable storage;
- installation in conformity with the standards in force by qualified personnel;
- supply with non corrosive water;
- maximum operating pressure 6 bar, except where otherwise indicated;
- the systems must be sealed: open surge tank is not admitted;
- the use of hemp or similar products is not permitted on the sealing points of the radiators;
- for electric radiators, resistances and liquid supplied and prepared exclusively by D.A.S. must be used for installation;
- the guarantee loses effect if, after the first filling, they are left without water;
- for external cleaning, abrasive or chemically aggressive products of any kind may not be used, as a cloth dampened with water is sufficient;
- the radiators may not in any way be subjected to stress and conditions of use which differ from their designed ones of heating elements. Our radiators are designed and manufactured to minimise possible injuries to people from blows. The elementary safety conditions must, however, be respected to avoid damage to people and/or things from striking them or from other ways. In the event of the presence of the disabled and children, particular precautions must be followed, moreover packaging must not be left in their reach;
- during installation extreme care must be taken to prevent damage to the radiator itself.

TOLERANCES

Conformity to the sample, both at the first and subsequent supplies, is not obligatory, as tolerance margins may exist both as regards colours as well as materials and measures.

MODIFICATIONS

D.A.S. has the right to modify or change the technical features like weight, measurements, surfaces, shapes, dimensions and other features illustrated in the price list at any moment and without prior notice, as long as it concerns indicative and not binding data.

CLAIMS

Claims are accepted within 8 days from receipt of the goods.

After this term they cannot be accepted by us.

RETURNS OF GOODS

The only accepted reason for returns is for ascertained manufacturing defects within the terms described in the conditions of sale. The customer is obliged to inform D.A.S. beforehand of the defects found and in the event of D.A.S. issuing authorisation to return them, the customer may make the return themselves. No other reasons for returns are accepted other than manufacturing defects.

Unauthorised returns will be returned to the sender.

D.A.S., in any case, reserves the right to control the claimed defect and charge for replacement if the damage to the radiator does not depend on manufacturing defects.

COURT OF JURISDICTION

For any dispute it is expressly agreed that the court of jurisdiction is exclusively the court of Monza and as regards anything not expressly agreed, the provisions of the laws in force.

CONDITIONS GÉNÉRALES DE VENTE

La commande implique l'acceptation intégrale de toutes les conditions de vente suivantes :

COMMANDES

Les commandes engagent définitivement le client qui doit déclarer qu'il connaît et qu'il accepte toutes les conditions de vente.

Seules les commandes effectuées par écrit, par fax ou par e-mail, seront acceptées. Une fois écoulé un délai de 24 heures après la confirmation de commande, si le travail a commencé, les commandes spéciales, par exemple en ce qui concerne les produits hors-taille ou colorés, ne peuvent plus être modifiées ni annulées.

Les commandes par téléphone doivent être confirmées par écrit. En cas de commande, de modification ou de spécification de commande qui ne serait que verbale, D.A.S. est soulevée de toute responsabilité concernant d'éventuelles erreurs d'exécution.

PRIX

Les prix de notre catalogue peuvent subir des variations et ils ne sont pas contraignants. Ils sont exprimés départ-usine de notre siège de Carate Brianza, sauf accords différents, et au net de la T.V.A.

RÈGLEMENTS

Les échéances spécifiées dans la facture sont impératives : toute variation n'ayant pas fait l'objet d'un accord préalable avec notre siège sera refusée. Les retards de paiement des fournitures seront sanctionnés par la mise au débit des intérêts, et nous nous réservons de suspendre la livraison et les commandes que nous aurions éventuellement déjà acceptées. Même en cas de réclamation les règlements ne peuvent pas être suspendus.

DÉLAIS DE LIVRAISON

Les délais de livraison ne sont pas contraignants et ne peuvent donner lieu à des indemnités ou à l'annulation des commandes. Si pour une raison quelconque le délai de livraison ne pouvait être respecté, le client n'a droit à aucune indemnité, il ne peut annuler ou modifier la commande ni en refuser l'expédition.

DONNÉES IDENTIFIANT LE CLIENT

Le client est responsable de toutes les données d'identification qu'il fournit à D.A.S. telles que : dénomination et raison sociale, siège légal, adresse éventuelle pour la livraison du matériel, code d'identification fiscale, inscription au registre des entreprises ou de la TVA, et tout ce que la législation en vigueur requiert, et il délivre D.A.S. de toute responsabilité en ce qui concerne l'inexactitude des données qu'il lui a fournies.

TRANSPORT

La marchandise voyage aux risques et périls du commettant même lorsqu'elle est vendue franco de port.

Le commettant a l'obligation de vérifier l'intégrité de l'emballage à la livraison et les réclamations éventuelles doivent être signalées sur le bulletin de livraison contresigné par le transporteur.

EMBALLAGE

L'emballage standard est compris dans le prix de vente, sauf emballages spéciaux qui seront débités à part.

RESPONSABILITÉ

Tous nos articles sont soumis à des essais et à des contrôles sévères. Notre responsabilité sur la qualité des matériaux se limite, sous réserve que nous en donnions l'autorisation, à accepter le retour, franco de port, des pièces défectueuses pour les remplacer, sans devoir verser aucune indemnisation. Nous déclinons toute responsabilité dans les cas où les pièces que nous avons fournies auraient fait l'objet d'altérations.

Toute indemnisation relative aux dommages directs ou indirects causés par la pose de matériel défectueux est exclue. Les acquéreurs ont l'interdiction formelle d'effectuer des transformations quelles qu'elles soient sur les articles de notre production.

GARANTIE ET CONDITIONS D'UTILISATION

Nos radiateurs ainsi que leurs finitions sont garantis contre les défauts de fabrication pendant deux ans, sous réserve que les conditions suivantes soient respectées:

- stockage adéquat;
- installation effectuée par du personnel qualifié et selon les normes;
- alimentation avec une eau non corrosive;
- pression maximale en service 6 bar, sauf indications différentes;
- les installations doivent être bouchonnées: le vase d'expansion doit rester fermé;
- ne pas utiliser de corde ou de matériaux similaires sur les fixations des radiateurs;
- pour les radiateurs électriques, utiliser des résistances et le liquide fournis et préparés exclusivement par D.A.S. pour l'installation;
- la garantie prend fin si après le premier remplissage les dispositifs sont laissés sans eau;
- ne pas utiliser de produits abrasifs ou chimiquement agressifs de quelque nature qu'ils soient pour le nettoyage externe, un chiffon humide est suffisant;
- les radiateurs ne peuvent en aucun cas être soumis à des sollicitations et à des conditions d'usage qui sortent de leur fonction d'appareils de chauffage. Nos radiateurs sont conçus et réalisés pour présenter un risque minimal de dommages aux personnes en cas de heurts. Dans tous les cas, les conditions élémentaires de sécurité pour éviter les dommages aux personnes et aux biens par heurt ou autre doivent être respectées. En présence de porteurs de handicap et d'enfants, prendre des précautions supplémentaires ; les emballages doivent être placés hors de portée des enfants;
- pendant l'installation le plus grand soin est recommandé pour éviter d'endommager le radiateur.

TOLÉRANCE

La conformité à l'échantillon, aussi bien lors de la première livraison que des suivantes, n'est pas absolue, dans la mesure où il existe des marges de tolérance aussi bien en ce qui concerne les couleurs que les matériaux et les mesures.

MODIFICATIONS

D.A.S. a la faculté de modifier ou de varier à tout moment et sans préavis les caractéristiques techniques comme les poids, les mesures, les surfaces, les formes, les dimensions et autres illustrées dans le catalogue, car il s'agit de données indicatives non contraignantes.

RÉCLAMATIONS

les réclamations doivent être faites dans les 8 jours à compter de la réception de la marchandise.

Après ce délai nous ne pourrions pas les accepter.

RETOURS DE MARCHANDISE

La seule raison admise pour les retours est le défaut de fabrication établi selon les termes décrits dans les conditions de vente. Le Client est tenu d'informer au préalable D.A.S. des défauts qu'il a relevés, et en cas d'autorisation de retour de la part de D.A.S., le Client peut procéder au retour. Aucune autre raison de retour que le défaut de fabrication n'est admise.

Les retours sans autorisation seront renvoyés à l'expéditeur.

D.A.S. se réserve dans tous les cas de vérifier le défaut déclaré et de mettre son remplacement au débit de l'acheteur au cas où les dommages au radiateur ne dépendraient pas de défauts de fabrication.

TRIBUNAL COMPÉTENT

Pour toute controverse il est expressément convenu que seules seront compétentes les autorités judiciaires de Monza, et les normes en vigueur pour tout ce qui n'est pas expressément convenu.

Le illustrazioni dei nostri prodotti
non costituiscono impegno di fedele
esecuzione.
*Our products illustrations are not pledge of
faithful execution.*

Art Director: Studio Poletti
Print: Fotolito Toscana
Edizione: Maggio 2010

D.A.S. radiatori d'arredo
Via dell'Industria, 3
20034 Giussano (MB)
tel. +39 0362 860455
e-mail: info@dasradiatoridiarredo.com
web: www.dasradiatoridiarredo.com



radiatori d'arredo

Via dell'Industria, 3 - 20034 Giussano (MB)
tel. +39 0362 860455
e-mail: info@dasradiatoridiarredo.com
web: www.dasradiatoridiarredo.com

www.dasradiatori.pl